

Article number: 20133B50B252BL

Description: E+G Two-way Connector  
GN133-B50-B25-2-BL

## Measures

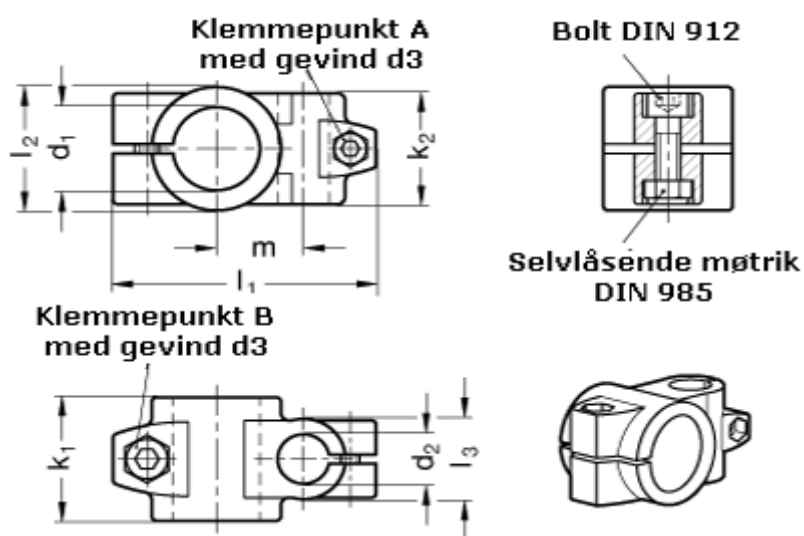

Adjustable clamp lever for d3 = GN 911-M10-55 have to be ordred separately

Adjustable clamp lever for d4 = GN 911-M 8-32 have to be ordred separately

d1	= 50
d2	= 25
d3	= M10
d4	= M 8
k1	= 65
k2	= 59

l1 = 122.0

l2 = 65

l3 = 40

m = 45